

Ford L Model with 5.9L Cummins

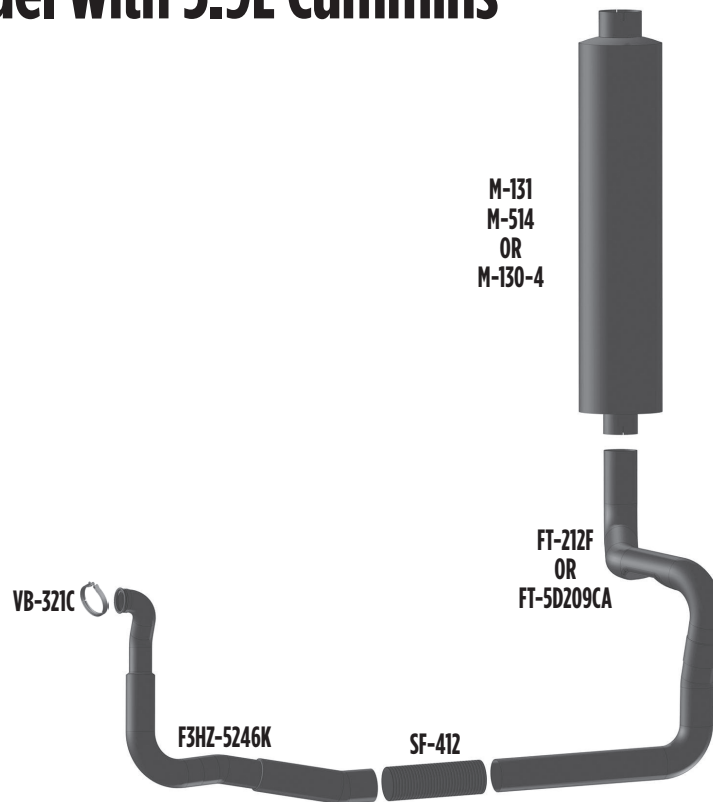

Ford L Model with Ford 6.6 or 7.8L Engine

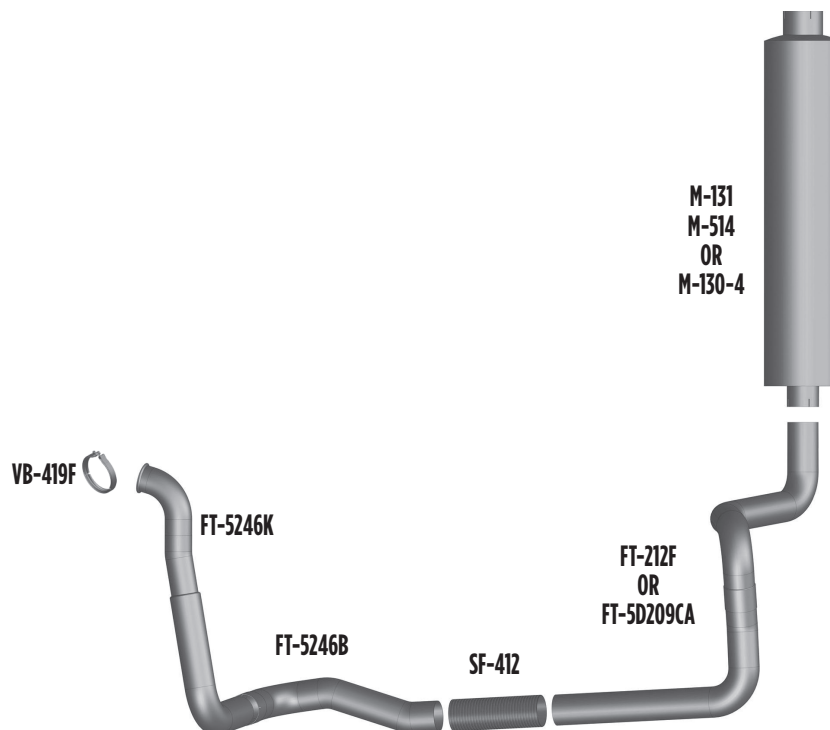

Ford L Model with Ford L10 or 8.3L Cummins

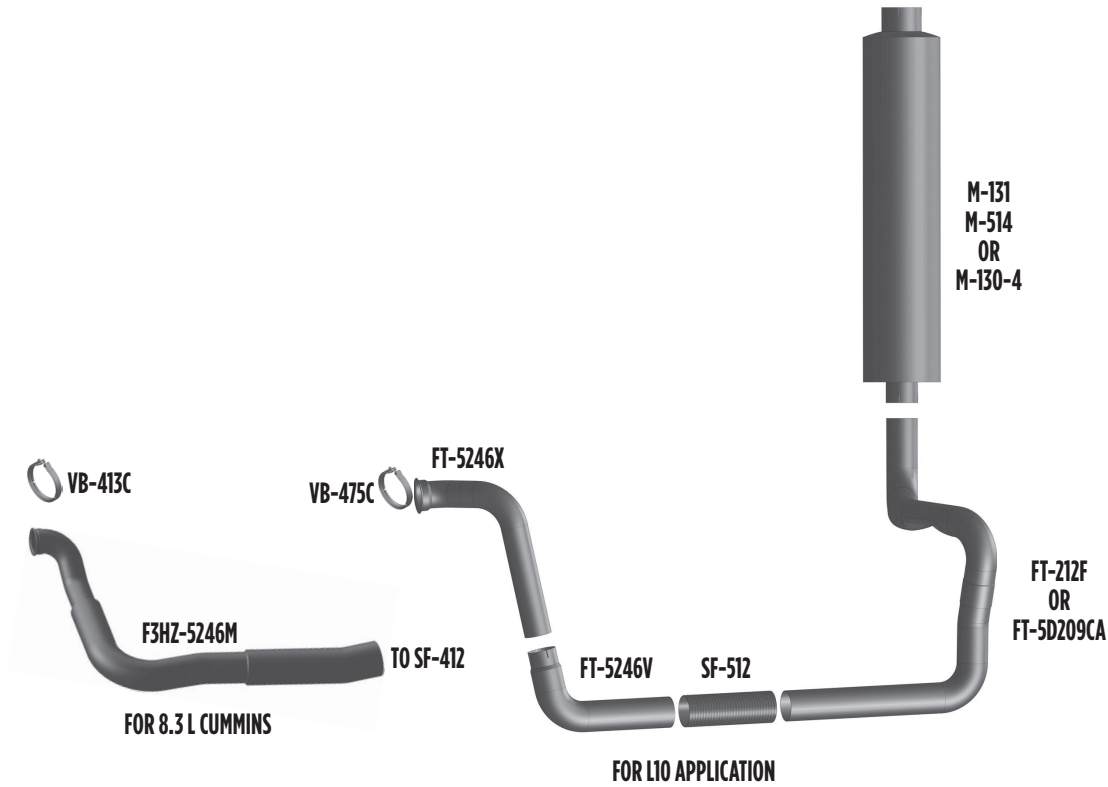

Ford L, LN, LNT & LTS Exhaust Layout

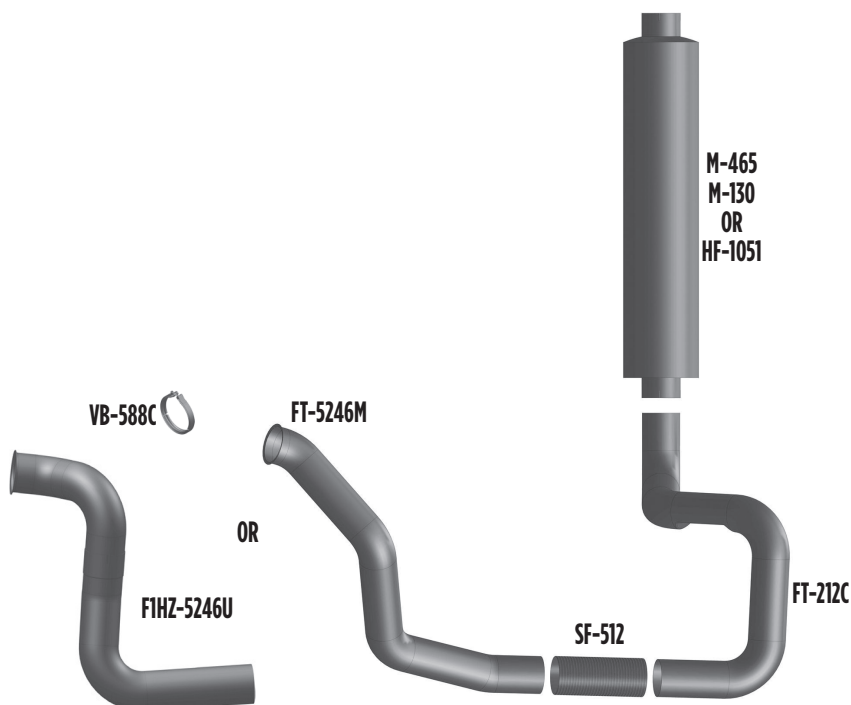

PART NO. F3HZ-5246K

- Compares to: F3HZ-5246K
- Use V-Band: VB-321C



PART NO. FT-5246K

- Compares to: E7HZ-5246K
- Use V-Band: VB-419F



PART NO. FT-5246B

- Compares to: F7HZ-5246B

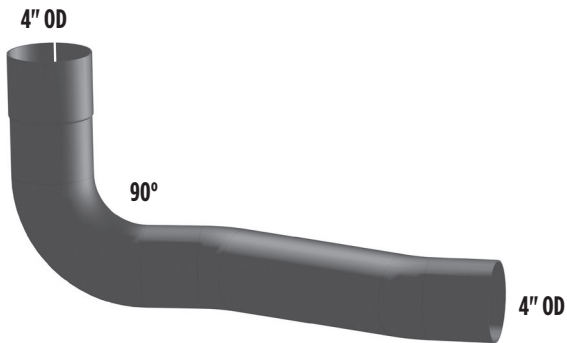

PART NO. FT-212F

- Compares to: E2HZ-5A212F

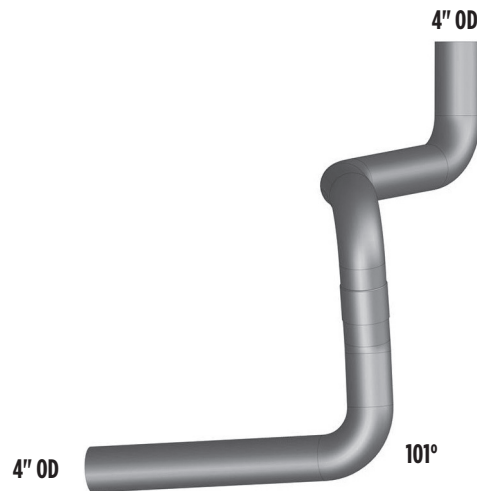

PART NO. FT-5D209CA

- Compares to: F1HZS-5D209CA



PART NO. F3HZ-5246M

• Compares to: F3HZ-5246M



PART NO. FT-5246X

• Compares to: E8HZ-5246X



PART NO. FT-5246V

• Compares to: E8HZ-5246V

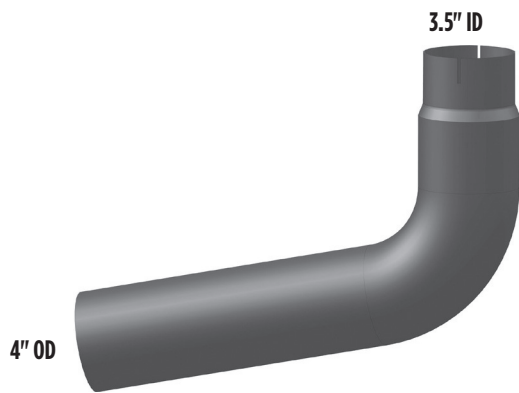

PART NO. FT-5246M

• Compares to: E0HZ-5246M



PART NO. F1HZ-5246U

• Compares to: F1HZ-5246U



PART NO. FT-212C

• Compares to: F2HZ-5A212C

